

Hotpoint®

**KEY CONTACT
NUMBERS**

SERVICE

UK: 0541 500 500

Republic of Ireland: 1850 302 200

GENUINE SPARES MAIL

ORDER HOTLINE

UK: 0541 530 530

Republic of Ireland: (01) 84268636

ACCESSORIES MAIL ORDER

HOTLINE

0541 530 530

EXTENDED WARRANTY

To join: 0800 716 356

Administration: 01782 388 252



**HOTPOINT
SLIMLINE
DISHWASHER**

**USER AND INSTALLATION
INSTRUCTIONS -
MODELS DC23/24**

1739986**678 (7711)** 56000**09780**

Hotpoint®

Before you operate your new Hotpoint Dishwasher

1. Follow the installation instructions (see page 22). Make sure that the machine is correctly installed.
Your dishwasher should **not** be located adjacent to a gas hob, cooker or heater as flames from the burners could cause damage to your machine.
2. For your own safety and to get the best out of your machine read right through this Handbook **before** using your machine. Once you have read through the Handbook the summary on pages 4 and 5 will remind you of how to operate the machine.
3. Get to know the main parts of your Dishwasher.

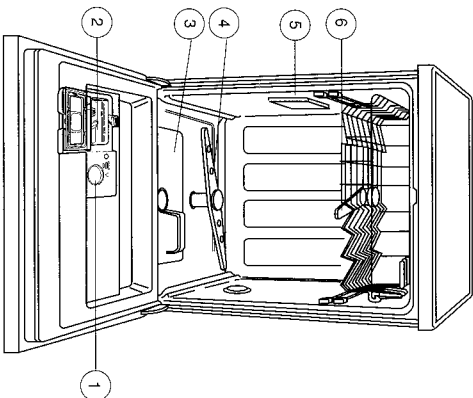

1. Rinse Aid container with level indicator (see page 10).
2. Detergent Dispenser (see page 11).
3. Filters (see page 18 for cleaning instructions).
4. Lower Spray Arm.
5. Salt Container incorporating Water Hardness Adjuster (see page 8).
6. Upper Basket.

NOTE: Do not attempt to stand on top of your dishwasher; it is not designed for such use and you could injure yourself or damage the appliance by such abuse.

Children should not be allowed to play with the appliance or tamper with the controls.

NOTE: CE marking certifies that this appliance complies with the requirements laid down in EEC Directive 89:336 (Electromagnetic compatibility) and subsequent modifications and Low Voltage Directive 73/23/EEC.

Contents

	page
Before you operate your new Hotpoint Dishwasher	2
How to do a wash	4
Dishwasher-proof items	6
Getting your Dishwasher ready to work	8
Setting the Water Hardness Adjuster	8
Salt, Rinse Aid and Detergent	9
Loading the Dishwasher	12
The Controls	14
Programme Guide	15
When the washing-up is done	16
Caring for your Dishwasher	17
If something goes wrong	19
If it still won't work	21
Installation Instructions	22
Hotpoint Service Cover	29
Hotpoint Service Offices and Spares Centres	back page
Appliance Manufactured in Germany	

Retention of this Instruction Book

This Instruction Book must be kept handy for reference as it contains important details on the safe and proper use of the appliance.

If you sell or pass the appliance to someone else, or move house and leave it behind, make sure this Book is also provided so the new owner can become familiar with the appliance and safety warnings.

If the Book is lost or damaged a copy may be obtained from Hotpoint Ltd, Morley Way, Peterborough PE2 9JB.

How to do a wash

Before using your new machine for the first time please refer to page 8, 'Getting your Hotpoint Dishwasher ready to work', before proceeding any further.

1. Turn on water

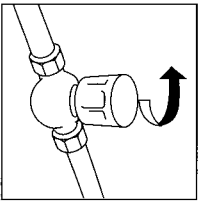

2. Plug in, switch on electricity

WARNING: WHEN SWITCHING ELECTRICITY ON OR OFF PLEASE ENSURE THAT YOUR HANDS ARE DRY.

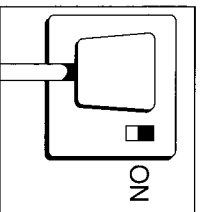

3. Add salt if necessary

Add salt via the Salt Dosage Tray (see page 10)

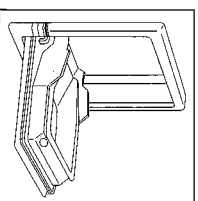

4. Check Filters

Make sure that the filters are clean and correctly positioned (see page 18) Remember to clean them at the end of the wash

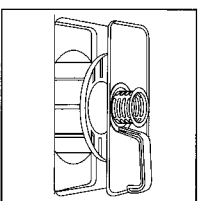

5. Load machine

Do not obstruct the spray arms or Detergent Dispenser

6. Check Rinse Aid Indicator

Ensure the window on the rinse aid dispenser is dark colour. If it is not, refill the dispenser (see page 10)

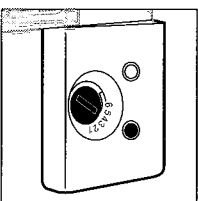

7. Add Detergent

Add relevant quantity of detergent based on type of wash (see pages 11 and 15)

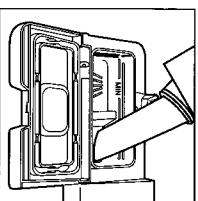

Hotpoint Service Cover

SATISFACTION GUARANTEED OR YOUR MONEY BACK

Hotpoint gives you a unique Satisfaction Guaranteed promise – valid for ninety days after you have purchased your Hotpoint product. If there is a technical problem with your Hotpoint appliance, just call Hotpoint Service. If necessary,

we will arrange for an engineer to call. If the technical problem is not resolved under this Guarantee, Hotpoint will replace your appliance or, if you prefer, give you your money back. Your statutory rights are not affected, and the Guarantee is additional and subject to the terms of Hotpoint's Five Year Parts Guarantee.

HOTPOINT'S EXTENDED WARRANTIES

Whether you have just one or a number of Hotpoint appliances in your kitchen, Hotpoint has a range of Service Plans to give you complete peace of mind. They enable you to extend your one year labour guarantee so that you can have repairs completed **FREE** during the membership period.

SERVICE COVER

We offer a number of payment methods: cheque, credit card or you can spread the cost and pay by direct debit. (Full details can be obtained on free phone 0800 716356). This covers you for all repairs during the period of cover, which can be from 1 to 4 years. Service Cover also includes loss of food, up to the value of £250, subject to verification by one of our engineers in refrigeration appliances. There is also an option of Service Cover with Maintenance at an additional cost. This includes an annual Electrical and Safety check and replacement of any parts as necessary.

KITCHEN COVER

An annual payment covers you for all repairs for all your Hotpoint appliances which are less than ten years old. It also covers the cost of loss of food up to £250 subject to verification by one of our engineers in our refrigeration and freezer products. There is also the option of Kitchen Cover with Maintenance at an additional cost. Any additional Hotpoint appliances purchased after you have joined Hotpoint Kitchen Cover will automatically be included during the annual period of cover without further charge.

APPLIANCE REGISTRATION

To ensure that you have the opportunity to benefit from any of the above Service Schemes and other offers you should complete and return immediately the Appliance Registration Form/Questionnaire supplied with this appliance. Full details and costs of our Service Schemes, together with an application form, will be sent to you at the end of the first year of the guarantee.

ANNUAL SAFETY/MAINTENANCE CHECKS

Hotpoint strongly recommends that all its appliances are regularly checked for electrical and mechanical safety, whether or not they are covered by a Service Plan. Worn door gaskets or hoses may cause a leak on an appliance, which could become dangerous if neglected.

PROOF OF PURCHASE

For future reference please attach your purchase receipt to this booklet and keep it in a safe place.

SPARES AND ACCESSORIES

Spares and accessories can be ordered from your local Hotpoint Genuine Spares Mail Order Hotline (see back page).

HOTPOINT'S FREE FIVE YEAR GUARANTEE

From the moment your appliance is delivered, Hotpoint guarantees it for **FIVE YEARS**.

- ★ In the Five Years all replacement parts are **FREE** provided that they are fitted by our own Service Engineer. During the first year our Engineer's time and labour is also free.
- ★ Our guarantee covers loss of food in our refrigeration and freezer products up to £250 during the first year, subject to verification by one of our engineers.
- ★ After the first year we will charge for our Engineer's time and labour. We do, however, operate a range of Service Plans (see opposite) which, for an annual payment, enables you to cover any repair costs which may be necessary.
- ★ All our service repairs are guaranteed for twelve months in respect of our labour and any parts fitted.

- ★ The appliance must be used in the United Kingdom, and must not be tampered with or taken apart by anyone other than our own Service Engineers.
- ★ You may however, buy parts which can be safely fitted without specialist knowledge or equipment. The correct fitting of such parts, provided they are genuine Hotpoint spares, will not affect your Guarantee. Parts are available from our Hotpoint Genuine Spares Mail Order Hotline (see back page).
- ★ Our Guarantee does not cover the cost of any repair, or loss of food in refrigeration products, due to power failure, accidents or misuse. Nor does it cover the cost of any visits to advise you on the use of your appliance.
- ★ If at any time during the Guarantee period we are unable to repair your appliance, we will refund any repair costs paid to us in the previous twelve months. We will also offer you a new appliance at a reduced charge instead of a repair.
- ★ Our Guarantee is in addition to and does not affect your legal rights.
- ★ Should you need independent advice on your consumer rights, help is available from your Consumer Advice Centre, Law Centre, Trading Standards Department and Citizens Advice Bureau.
- ★ All Hotpoint servicing is carried out by our own Service Organisation located throughout the United Kingdom and Eire. We will be happy to deal with any problems which you may have.

NOTE: Our Engineers will use every effort to avoid damage to floor coverings and adjacent units when carrying out repairs/service work, but in locations where the Engineer advises you that it will be impossible to move the appliance without risk of damage, he will only proceed with your approval that no liability is accepted.

Service, Accessories and Spares

If you wish to have an Installation Check or require any other service please contact Hotpoint Service (see back page).

Accessories and Spares

Orders for accessories and spares can be obtained from Hotpoint Accessories Mail Order Hotline (see back page).

In accordance with its policy of progressive product design, the Company reserves the right to alter specifications.

8. Close door

Make sure that the dishwasher door clicks shut

9. Select programme

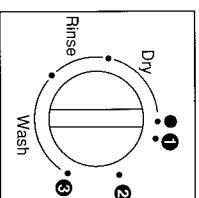

Turn the Programme Selector clockwise until the programme number lines up with the mark on facia

10. Switch on machine Model DC23

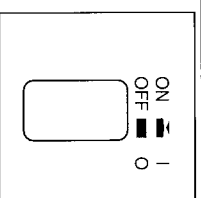

Press the On/Off button so that the Mains Indicator Light comes on.

Model DC24

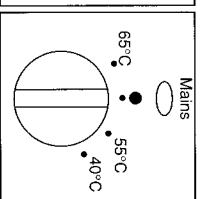
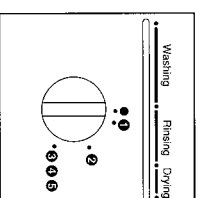

DC24 Select the programme you require and select the temperature.

11. Switch off the machine Model DC23

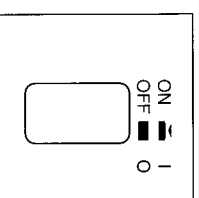

When the wash is complete press the On/Off button so that the Mains Indicator Light goes off

Model DC24

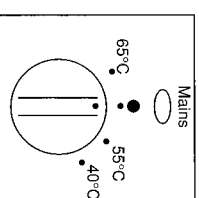

Turn the temperature Selector Control to ● (off).

12. Switch off electricity

WARNING:
WHEN SWITCHING ELECTRICITY ON OR OFF PLEASE ENSURE THAT YOUR HANDS ARE DRY.

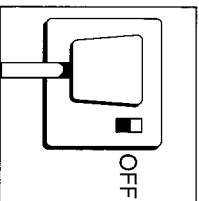

Turn off taps

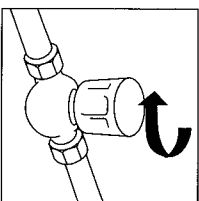

13. Remove wash load

Allow 15 minutes for the load to cool.
Unload lower rack first
Remember to clean the filters
(see page 18)

What items are not dishwasher-proof?

This is always the first question asked by anyone who has bought a dishwasher for the first time, so we will answer it before we go any further.

The items **not** suitable for washing in a dishwasher are:

- Cutlery with wooden or bone handles
- Pans with wooden handles
- Parts joined by adhesive
- Plastic, copper or tin items which cannot resist hot water
- 'On-glaze' decorated china, aluminium and silver items can discolour or fade
- Lead crystal glassware.

If you are in any doubt check with the manufacturers of the china, pans, and cutlery on their dishwasherability.

Can I only wash dishes in my dishwasher?

No, there are many more items you can wash in a dishwasher than you imagine, for example:

Oven furniture, hob fittings, stainless steel items, teapots, coffee pots, food processor and mixer attachments, glass microwave turntables.

If you are in any doubt check with the manufacturers of the items on their dishwasherability.

WARNING: DO NOT ATTEMPT TO WASH ITEMS IN YOUR DISHWASHER WHICH HAVE CONTAINED POISONOUS OR DANGEROUS SUBSTANCES.

Drainage

1. Methods of drainage

We only recommend two methods. Permanent discharge into a fitted standpipe or temporary discharge in to a sink. Whichever one is used make sure that the discharge hose is not kinked. **Do not attempt to shorten the discharge hose.**

The height above the floor level (on which the dishwasher stands) of the standpipe or sink must be a minimum of 500mm (20in) and a maximum of 1.1m (43in).

Method 1:

Into a fitted standpipe. The standpipe should have a bore of at least 32mm (1 1/4in). It should have a trap fitted and **must be connected to the same drain system as your household sinks. It must not be connected to a surface water drain.**

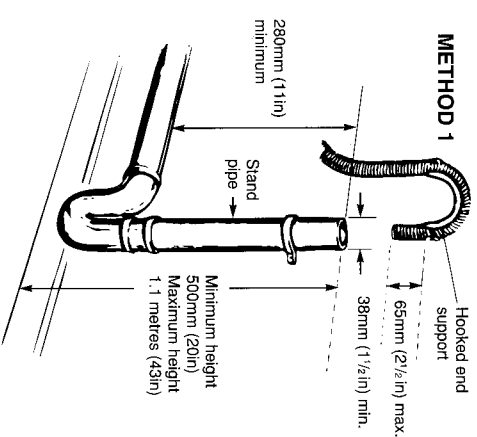

Method 2:

Into a sink. The sink should have an outlet pipe with a minimum diameter of 32mm (1 1/4in). Always remove the sink plug and hook it behind a tap. Make sure that dishcloths etc. cannot fall into the sink and block it. Make sure that the end of the hose is above the water level in the sink to avoid siphoning.

Important: Do not use any other method of drainage. Always use the hooked end support which must be within 65mm (2 1/2in) of the end of the hose.

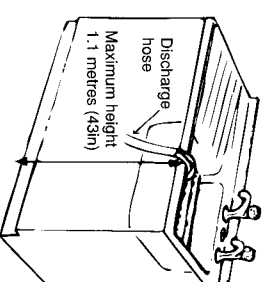

2. Extending the Discharge Hose

An extension hose (Part No. 9067) may be purchased from your retailer or nearest Hotpoint Accessories Mail Order Hotline (see back page) using the accessories order form supplied. This allows for extension to the maximum permissible length of 4m (13ft). The hooked end support must be replaced no more than 65mm (2 1/2in) from the end of the hose to prevent siphoning.

plate elbow which are standard plumbing items and can be obtained from plumber's merchants and DIY shops. If your pipes are not 15mm diameter copper, consult a local plumber.

Method 1:

With this kit (Part No. 9051) no drilling is required and there is no need to shut off the water. It comes complete with all fittings and instructions.

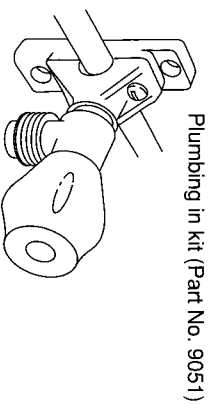

Method 2:

Has a stopcock and other fittings as shown, plus extra 15mm 1/2in copper tube.

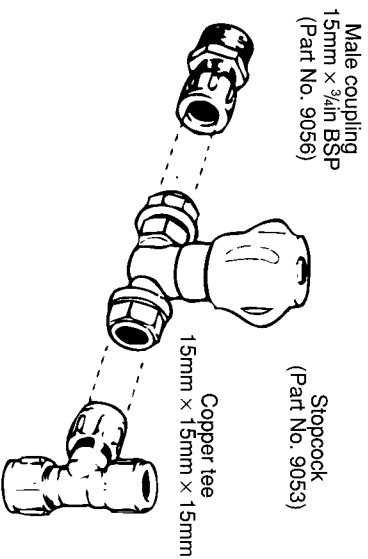

Method 3:

Uses a tap body and wall plate elbow as shown, plus extra copper tube.

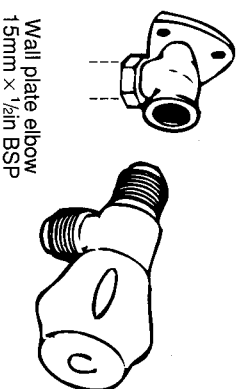

Method 4:

Uses a tap body and tee (as shown in Method 2) plus extra copper tube.

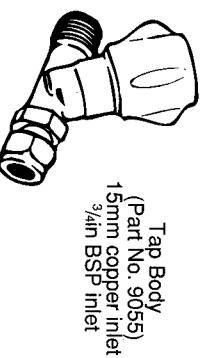

Special care notes

Stainless steel items

Stainless steel is very good for washing in the dishwasher. Some types however can become tarnished by the humid atmosphere in the dishwasher during drying. To avoid this remove the items at the end of the rinse programme and wipe dry. Any staining will not harm the items and can be removed with a proprietary stainless steel cleaner.

Silverware

Silverware can be washed in your dishwasher but should not be washed alongside stainless steel items as this could cause corrosion of the stainless steel. To 'polish' tarnished silver and A1 EPNS, Hotpoint makes a *Silverware Cassette*, Part No. 7004. This can be ordered through your retailer or nearest Hotpoint Spares Centre, see back page, using the enclosed order form.

It is placed in the cutlery basket and the silver cutlery placed inside. The areas of discolouration will disappear after a few washes.

It should be noted that any decorative toning on the handles of silverware will eventually fade, so if this is of particular importance to you do not wash such items in the dishwasher.

Aluminium items

Bright polished, matt, enamelled and non-stick coated aluminium items are all suitable for washing in a dishwasher.

However aluminium is vulnerable to everyday minerals found in water, which could lead to discolouration during rinsing. If items show signs of discolouration they should be removed immediately after the washing cycle and rinsed in cold water by hand. This discolouration will not, however, seriously affect the aluminium.

WARNING: TAKE SPECIAL CARE WHEN REMOVING ITEMS IMMEDIATELY AFTER A WASH AS THEY MAY BE VERY HOT.

Getting your Hotpoint Dishwasher ready to work

Before you can use your Dishwasher you must first carry out the following steps to ensure that you obtain the best possible wash performance from your machine.

Setting the Water Hardness Adjuster

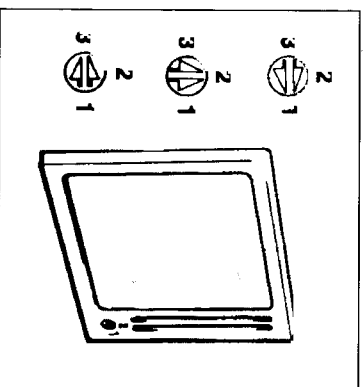

Water contains varying amounts of lime and mineral salts depending on the area in which you live: these are deposited on dishes leaving white marks.

The higher the content of these salts, the harder your water will be. The 'hardness' level is measured on 2 equivalent scales: French Degrees or Clarke Degrees.

The dishwasher is equipped with a softener which uses special dishwasher salt to produce lime-free (softened water).

In order to ensure that the correct amount of salt is being used to regenerate the water softener, the Water Hardness Adjuster needs to be set accordingly. To

set this you need to ascertain the degree of hardness of your water supply.

Use a small coin to select the setting required.

3. Temporary Plumbing

Your tap should be in good condition or it may leak when turned full on. Mixer taps are not suitable for this use and, if you have them, you will need to use permanent plumbing (see below).

To connect the fill hose to a tap, you will need an adaptor. Unfortunately, there is no one adaptor which can be used on all taps. We recommend the ones shown here as being suitable for most modern taps.

Hotpoint Two Way Tap Adaptors, (Part No 9058), fit 1/2in-1in round and oval taps. They also allow you to use water at the sink whilst the machine is working.

If you have a square-spouted ('fashion') tap then you can use a Fashion-tap adaptor, (Part No. 9059).

If you have a tap with a 1/2in or 5/8in BSP threaded outlet then you will need to use a tap thread adaptor (Part No. 9057).

All these adaptors can be purchased either from your retailer or nearest Hotpoint Accessories Mail Order Hotline (see back page).

If you have an existing installation, please check that this includes a tap or stopcock to isolate the appliance. If not, use one of the methods shown below. If your installation has a 1/2in or 5/8in BSP male connector you will need to purchase an adaptor Part No. 9057, from your retailer or nearest Hotpoint Accessories Mail Order Hotline.

Permanent Plumbing

The following aspects must be considered when installing permanent plumbing: It may be necessary to offset any plumbing to give enough clearance behind the dishwasher to allow it to be built-in. You may also need to do this with any electrical connections.

There **must** be a tap or stopcock so that the water supply can be turned off thus isolating the machine from the household supply.

Find out from a local plumber about your local water authority's regulation governing connection to the cold water supply. Some allow direct connection to the mains, others require you to take your supply from the header tank in the roof. If you feel unsure about installing plumbing yourself, consult a local plumber.

We recommend all of the following methods using existing 15mm (1/2in) copper pipe. All the fittings shown can be obtained from your retailer or local Hotpoint Accessories Mail Order Hotline with the exception of the copper tee and the wall

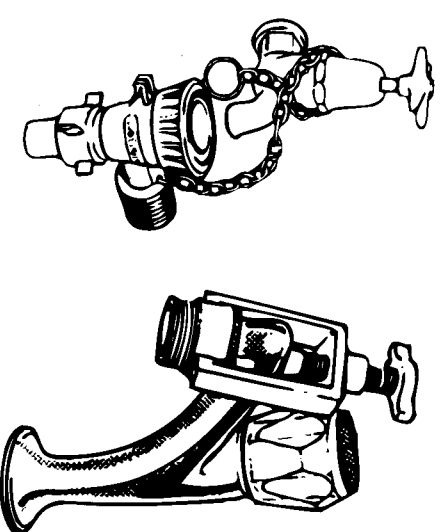

Decor Panel Sizes:

Door – Height 600mm x 435mm. Thickness – panels up to 8mm thick can be used but they must be trimmed down to 4mm, 3.5mm in from each edge (see Fig. 1).

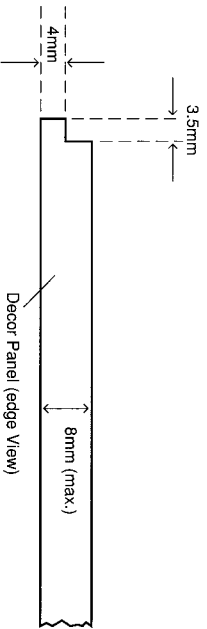

Water supply

Pressure

Your dishwasher requires a pressure in the range 4-103N/cm² (6-150 psi). Most water supplies via a cold water storage tank will be above the minimum pressure if the tank is one or two floors above the appliance.

IMPORTANT: INSTANTANEOUS GAS AND ELECTRIC WATER HEATERS MUST NOT BE USED; HOT FILL SHOULD NOT BE USED AS IT WILL IMPAIR THE DRYING PERFORMANCE.

Plumbing

1. Fill Hose

You are supplied with a fill hose fitted with a 3/4in BSP female connector for connection to standard 3/4in BSP threaded appliance taps. The hose is suitable for cold water fill. A 1.2m (4ft) extension hose (Part No. 9062) can be ordered from your retailer or nearest Hotpoint Accessories Mail Order Hotline (see back page) using the accessories order form supplied. Whichever plumbing method is used do not shorten the hose and ensure that it is not kinked.

2. Methods of Plumbing

Two methods of plumbing are acceptable. Temporary plumbing on to a sink tap using a tap adaptor or permanent plumbing to the water supply via a 3/4in BSP threaded appliance tap or stopcock. Permanent plumbing is preferable.

Find on the table right the level corresponding to the hardness of your water and the required adjustments.

Contact your local water company to find the exact water hardness level for your area.

If you are in any doubt, please consult your nearest Hotpoint Service Centre for advice (see back page).

After setting the water hardness adjuster you will need to add salt to the machine (see below).

NOTE: AFTER SETTING THE WATER HARDNESS ADJUSTER, YOU WILL NEED TO ADD SALT TO THE MACHINE. SEE BELOW.

Water Hardness chart

Hardness	Grains per British Gallon or British (Clarke) Degrees	Regenerating Salt Guide
Extremely Hard	30	Setting 3
Very Hard	28	Setting 2
	24.5	
Hard	21	Setting 1
	18	
Moderately Hard	14	Select Setting 1 but do not add salt
	10.5	
Slightly Hard	8.5	
	7	
Moderately Soft	3.5	
Soft	1.75	
	0	

Salt, Rinse Aid and Detergent

In order to function properly your dishwasher needs a supply of the above three items. Salt and rinse aid are replenished occasionally. Detergent is added every time you wash a load.

Various manufacturers sell dishwasher rinse aid and detergent, most of which are suitable for your Hotpoint dishwasher. We particularly recommend *Finish* detergent and rinse aid as they give excellent results on all programmes and loads.

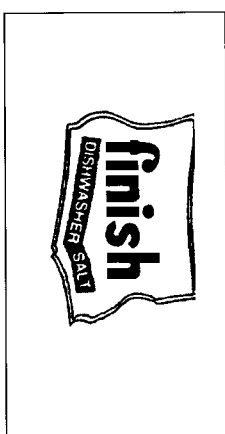
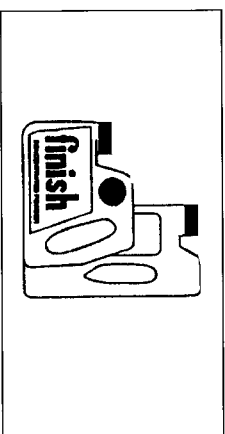

Salt

Salt is used to regenerate the resins in the water softener which aids both washing and rinsing, and avoids the furring-up of the internal parts of the machine.

NOTE: Only use special granular salt. Do not use table salt, cooking salt or road salt as they contain insoluble substances which could harm the dishwasher. IMPORTANT: Do not use tablet salt.

Filling the Salt Container

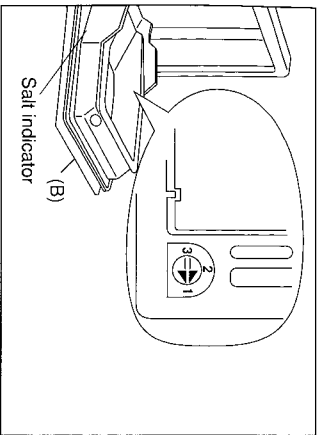

Open the Salt Container by pressing down the blue Salt Door catch (B). Weigh out 0.5kg granular salt. When the machine is being filled for the first time you should:

- 1) Remove the Salt Dosage Tray. Fill the tray with salt.
- 2) Pour in 0.5l (1pt) of water directly into the Salt Container.
- 3) Replace the tray onto the Salt Door and close gently but firmly.
- 4) Repeat again until you have added approx. 0.5kg (1.1lb) of granular salt. This should be sufficient for approximately 15-20 washes.
- 5) Close the Dishwasher door and switch the machine to Prewash, which will rinse away any spilled salt solution.

Refilling the Salt Container

Repeat steps 1, 3, 4 and 5 as shown above after 15-20 washes or when the blue salt refill indicator is visible. The rate of replenishment may be adjusted in the light of your own experience, see page 16 which highlights the faults found on washing with too little salt.

Rinse Aid

Rinse Aid ensures quick drying and avoids the water spots and streaks which normally occur when a wet object is allowed to dry in the air.

NOTE: Only use rinse aid designed for use in dishwashers, do not use normal washing-up liquid.

Filling the Rinse Aid Container

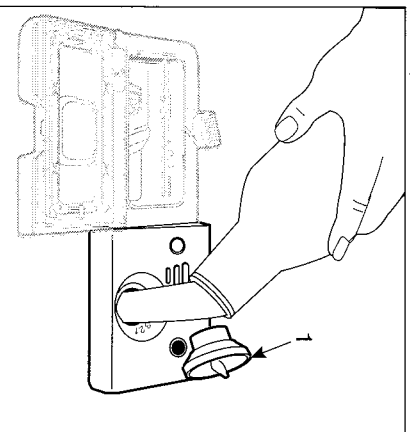

The Rinse Aid Container is located on the back of the dishwasher door (see page 2).

Open the container by turning the lid $\frac{1}{8}$ turn anti-clockwise (arrow 1). Pour in approximately 100ml of rinse aid. Close the lid firmly.

Mains lead replacement

Should the mains lead need replacing at any time please contact your nearest Hotpoint Service Office (see back page). A charge will be made for the replacement of the mains lead if you have damaged the lead or if you require a longer lead.

Positioning and adjusting your appliance

WARNING: BEFORE DOING ANY POSITIONING OR ADJUSTMENTS TO YOUR APPLIANCE YOU MUST ALWAYS ENSURE THAT THE ELECTRICAL AND WATER SUPPLIES ARE DISCONNECTED AND THE PLUG IS REMOVED FROM THE SOCKET.

1. Location

You should put your dishwasher where it is easy to use and as close as possible to the water supply and drainage standpipe or sink. If you want your dishwasher to line up flush with other kitchen units then the water supply tap and standpipe must be offset either to the left or right of your appliance.

2. Low Kitchen Worksurfaces

Your dishwasher is 850mm (33 $\frac{1}{2}$ in) high and will fit under most kitchen worksurfaces. If, however, your worksurface is lower than the height of your appliance can be reduced to 820mm (32 $\frac{1}{4}$ in) by removing its work top. To do this remove the four fixing screws from the work top and lift it off. When the dishwasher is in position its top flange must contact the underside of the worksurface otherwise the door lock operation will be faulty.

3. Levelling

The feet are fully adjustable and can be adjusted to acquire the correct height, by using the spanner supplied.

With the appliance in its final position adjust the two front feet to ensure that it is level to within 2° using a spirit level.

Decor Panels

For a really 'built-in' appearance you can fit decor panels to the front of your dishwasher to match your kitchen units. Decor panels are available from most kitchen manufacturers.

Installation Instructions

Contents

Electrical Requirements.....	22
Positioning and adjusting your appliance	23-24
Water Supply	24
Plumbing.....	24-27
Drainage	27
Service accessories and spares	28

Electrical Requirements

We recommend that this appliance is connected to the mains supply via a suitable switched socket in a readily accessible position.

All Hotpoint appliances come complete with a fitted plug. The plug on your Dishwasher has a 13A fuse. If the plug does not fit your sockets a new plug can be fitted. Cut off the old plug and throw it away, do not insert it into a socket elsewhere in the house as this could cause a shock hazard.

WARNING – THIS APPLIANCE MUST BE EARTHED.

IMPORTANT – Fitting a Different Plug:

The wires in this mains lead are coloured in accordance with the following code:

Green and Yellow	— Earth
Blue	— Neutral
Brown	— Live

If you fit your own plug the colours of these wires may not correspond with the identifying marks on the plug terminals. This is what you have to do:

1. Connect the green and yellow (Earth) wire to the terminal in the plug marked E or with the symbol \equiv or coloured green or green and yellow.
2. Connect the blue (Neutral) wire to the terminal in the plug marked N or coloured black.
3. Connect the brown (Live) wire to the terminal marked L or coloured red.

With alternative plugs a 15A fuse must be fitted either in the plug or adaptor or in the main fuse box. In the event of replacing a fuse in the plug supplied, a 13A ASTA approved fuse to BS 1362 must be fitted.

If the plug is the moulded on type the fuse cover must be refitted when changing the fuse. In the event of losing the fuse cover the plug must **not** be used until a replacement fuse cover has been obtained and fitted. A new fuse cover can be obtained from your nearest Hotpoint Service Office or local electricity company. The colour of the correct replacement fuse cover is that of the coloured marks or insert in the base of the plug.

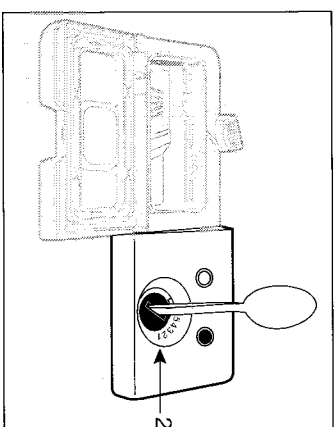

Adjusting the Rinse Aid Dispenser

The dispenser automatically adds rinse aid to the final rinse. It can be adjusted using the slot shown (arrow 2).

Any position from 1-6 can be chosen, the higher numbers dispense more rinse aid. We suggest that you initially set the dispenser in position 3 or 4 and then adjust it in the light of your own experience.

Page 20 highlights the faults found on washing with too much or too little rinse aid.

Rinse Aid Refill Indicator Window

When full this window will appear as a dark colour (arrow 3). When the window becomes light colour you should refill the dispenser as above.

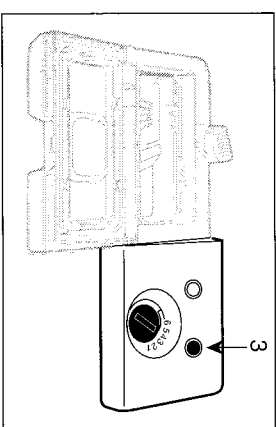

Detergent

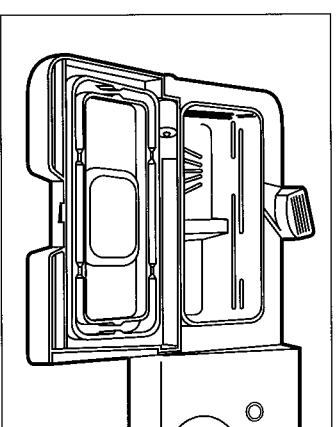

The Detergent Dispenser is next to the Rinse Aid Dispenser, and it should be filled before each wash (see page 15).

Filling the Detergent Dispenser

The dispenser will normally be open after a programme is finished.

The dispenser has two chambers. If you are using the Super and Normal Wash programmes fill the larger 150cc chamber. If you are using Light Wash programme fill the smaller 100cc chamber. For Economy wash fill either large or small detergent chamber depending on the level of soil remaining on the items to be washed (see Programme Guide, page 15). You can of course vary these quantities in the light of your own experience.

When filled close the lid firmly so that it clicks shut. It will automatically spring open during the programme to release the detergent.

NOTE: Only use special dishwasher detergent. Do not use ordinary washing-up liquids or washing powders.

Always add dishwasher detergent at the beginning of a programme. If you attempt to add detergent when the programme selector is part way through a programme it may not be possible to close the detergent dispenser.

Turning the timer knob completely through the wash programmes will open the dispenser and allows the detergent to fall into the machine.

Loading the Dishwasher

Your dishwasher is designed to take eight standard place settings.

There is no one correct method for loading the dishwasher. The upper and lower baskets are designed to give the maximum flexibility possible to cope with the almost infinite variety of cups, glasses, dishware, pots, pans and utensils – not to mention your oven fittings or teapot – which might be put into them.

Loading

- First remove all excess food, as you would for hand washing.
- Arrange all items so that water can drain away, as you would on a draining board.
- Large or heavily soiled articles should go in the lower baskets. Smaller, delicate items (eg. glasses) should go in the top basket.
- Arrange plates so that they are not touching and water can flow freely between them.
- Cups/Glasses should be placed at an angle so that water is not retained.
- Long stemmed glasses should not lean against dishware.
- Cutlery should be distributed at random in the cutlery basket with handles down (except if the handles are very thin and could drop through the basket).
- Long cutlery, such as ladles and knives should be laid horizontally across the filled cutlery basket.
- Pots and pans with baked-on areas should be arranged so that the water jets have direct access to the dirty areas.
- After loading check that the upper spray arm is free to rotate by giving it a spin with your hand.

WARNING: MAKE SURE LIGHT PLASTIC/WOODEN ITEMS ARE WEIGHTED DOWN WITH HEAVIER OBJECTS SO THAT THEY CANNOT BECOME DISLODGED. TAKE EXTRA CARE WHEN LOADING AND UNLOADING SHARP ITEMS SUCH AS KNIVES.

If it still won't work . . . Spare Parts

Contact the Service Office

If something is still wrong with your machine after you've been through the check-lists on the previous two pages:

1. Switch off and unplug your machine from the mains.
2. Turn off the cold tap.
3. Call your nearest Hotpoint Service Office or local importer (outside the UK). The telephone number is shown on the back page. You can note down the number in this space for convenience:

When you contact us we will want to know the following:

1. Your name, address and post code.
2. Your telephone number.
3. Clear and concise details of the fault.
4. The Model number and the colour.
5. The date of purchase. Enter the date here:

6. If you have taken out a Hotpoint Service Cover Plan.

Please make sure you have all these details ready when you call.

Please remember your new appliance is a complex piece of equipment.

'DIY' repairs or unqualified and untrained service people may put you in danger, could damage the appliance and might mean you lose cover under Hotpoint's Parts Guarantee.

If you do experience a problem with the appliance don't take risks; call in Hotpoint's own Service Engineer. The address and telephone number of your nearest Hotpoint Service Office is in your local telephone directory.

Our spare parts are designed exclusively to fit only Hotpoint appliances. Do not use them for any other purpose as you may create a safety hazard.

White deposit left on dishes/Glasses dull or misty

- Possible causes:
1. The salt has run out (see page 10).
 2. Rinse aid dosage is set too low (see page 10).
 4. Salt door is not securely closed (see page 10).

Glasses have greasy smears

Make sure that the rinse aid dosage is not set too high (see page 11).

Dishes still wet after drying

Make sure that:

1. Rinse aid dosage is not set too low (see page 11).
2. Water can drain off freely and not collect during drying (see pages 12 and 13).

Food specks left on dishes

Make sure that the filters are properly seated (see page 18).

Water left under the filter

This is perfectly normal.

Tea/Coffee stains and lipstick left on cups and glasses

You may be using too little detergent (see page 15).

Results are unsatisfactory

Possible causes:

1. Insufficient detergent used (see page 15).
2. Programme Selector turned after filling detergent dispenser causing detergent to be lost.
3. Not correctly loaded/overloaded baskets (see page 12).
4. Salt needs filling (see page 10).
5. Incorrect rinse aid setting (see page 10).
6. Filters incorrectly fitted or blocked (see page 18).
7. Nozzles in spray arm blocked (see page 17).
8. Spray arms obstructed by the dishes (see pages 12 and 17).
9. Incorrect programme selected (see page 15).

Rattling noises

Make sure that the utensils are correctly arranged (see pages 12 and 13).

Detergent dispenser won't close

Make sure that the Programme Selector is not part way through a programme.

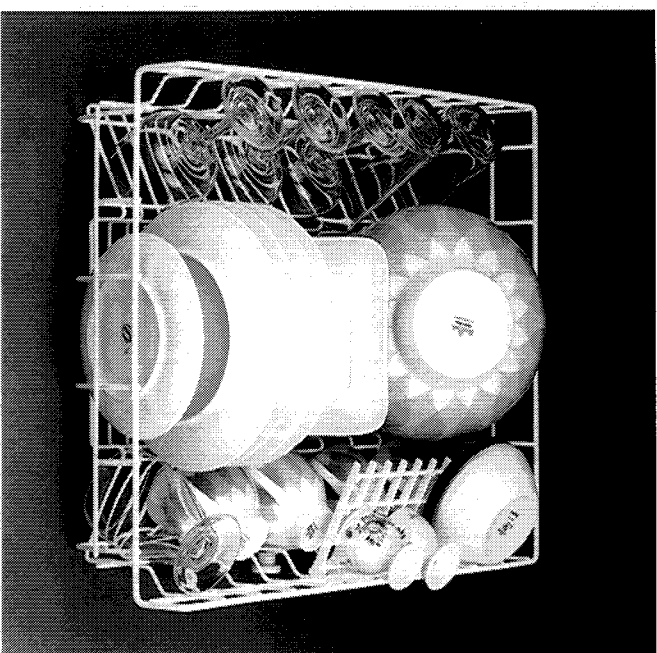

Upper Basket

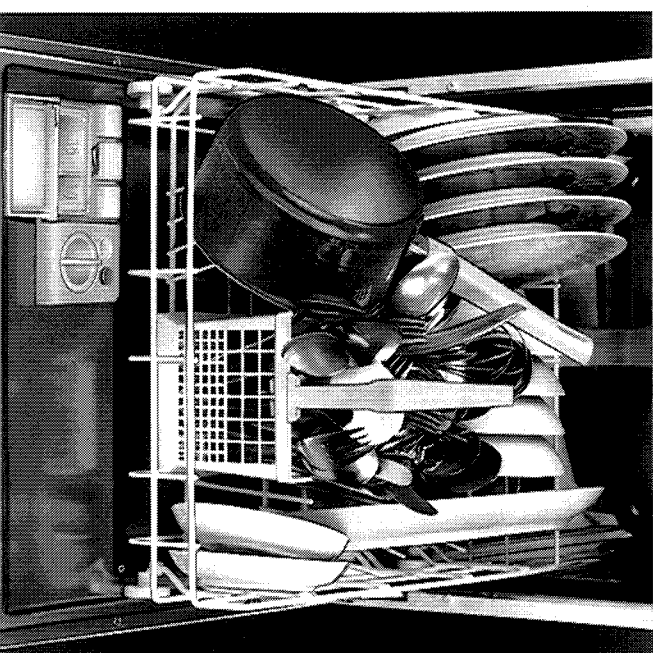

Lower Basket

The Controls

Model DC23

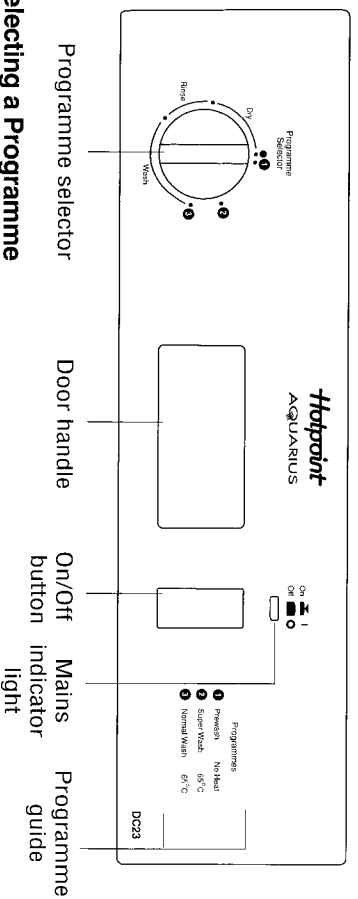

Selecting a Programme

Turn the Programme Selector **clockwise** until the programme number on the knob lines up with the mark on the fascia above the knob. You will feel a positive click as you reach the correct position (see opposite for Programme Guide).

NEVER attempt to turn the Programme Selector anti-clockwise, you could damage the timer.

Starting the Machine

Simply press in the On/Off button. The Mains Indicator Light will then come on and you will hear the dishwasher begin to work.

Programme Progress Indicator

As the programme proceeds the Programme Selector will turn indicating the stage the programme has reached as follows:

Wash — Rinse — Dry.

Please note that during periods where the water is being heated the indicator will remain stationary for some time so don't worry.

Model DC24

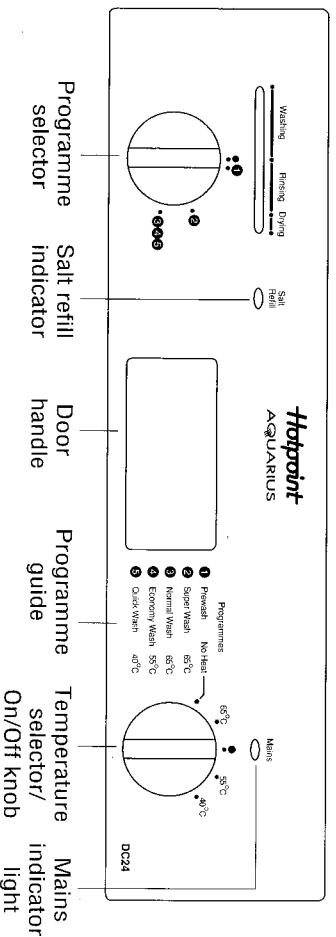

Selecting a Programme

Turn the Programme Selector **clockwise** until the programme number on the knob lines up with the mark on the fascia above the knob. You will feel a positive

If something goes wrong . . .

First, don't panic! There may be nothing wrong at all.

Look for your problem below, then check the things we suggest. More often than not this will give you the answer to your problem, and you'll be able to carry on without having to telephone your Hotpoint Service Office.

If after this you still cannot get your machine to work, follow the advice given on page 21.

Problem

Checklist

It won't start

Make sure that:

1. The machine is plugged in and switched on at the socket.
2. The door is securely closed.
3. You have selected a programme and switched on.
4. The water supply is turned on.
5. The inlet hose is not kinked.
6. The fuses in the plug and main fuse box are OK.

Try plugging in another appliance to check. If the fuse has blown refer to Electrical Requirements on page 22 of the Installation Instructions.

It won't fill

Make sure that:

1. You have not forgotten to turn on the tap.
2. The inlet hose is not kinked.

It won't empty

Make sure that:

1. The drain hose is not kinked.
2. The filters are not blocked (see page 18).

The machine's leaking

Make sure that:

1. The inlet and drain hoses are firmly attached to the machine.
2. The inlet hose is firmly attached to the water supply.
3. If your machine **is not** permanently plumbed in, did you empty the hose into a bucket after disconnecting it from the cold water tap?
4. If your machine **is** permanently plumbed in is the standpipe at the correct height 500 (20in min) and is it the correct bore size 32mm (1¼in)?
5. Could it be condensation from the wall?

It keeps stopping and making clicking noises

Don't worry, the timer is working and selecting the next operation, and there are also pauses whilst the water heats up.

Cleaning the Filters

This is the most important item of maintenance you have to do.

The filters are found on the bottom of the machine in front of the lower spray arm (see page 2).

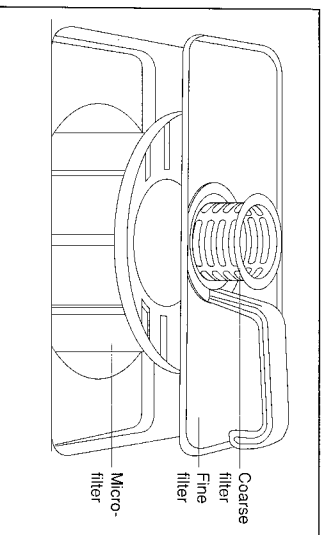

The filters can be lifted out by the handle. They are simply pushed together and are easily separated. They should be cleaned under running tap water after every wash. The microfilter fits into the base of the machine and can be removed by lifting straight upwards.

It should be inspected in place after every wash and removed and cleaned when necessary, and at least after every five washes.

When replacing make sure that the microfilter edges are flush with the base of the machine. The coarse and fine filters should then be reassembled and located back inside the microfilter, again with the edges flush with the base of the machine.

click as you reach the correct position (see opposite for Programme Guide). **NEVER attempt to turn the Programme Selector anti-clockwise, you could damage the timer.**

Starting the Machine

Turn the Temperature Selector/On/Off knob to the required temperature. The machine will start the programme selected.

Programme Progress Indicator

The Progress Indicator above the Programme Selector will indicate the progress of the programme.

Please note that during periods where the water is being heated the Indicator will remain stationary for some time so don't worry.

Programme Guide DC23 & DC24

Programme	1	2	3	4	5
	Prewash	Super wash	Normal wash	Economy wash Model DC24	Quick wash Model DC24
Temperature	No heat	65°C	65°C	55°C	40°C
Type of utensil	All	Glasses Fine porcelain Breakfast dishes Supper dishes Daily dishes Cooking utensils & pots Cutlery Oven/Hob fittings	Glasses Fine porcelain Breakfast dishes Supper dishes Daily dishes Cutlery	Glasses Fine porcelain Breakfast dishes	Very lightly soiled, dainty dishes Glasses Items that need freshening up
Soiling level	All	Heavy	Normal	Light to normal	Light only
Load level	Full	Full	½-Full	Full	Full
Detergent quantity	None	15cc Large Chamber	15cc Large Chamber	15cc Large Chamber	10cc small chamber
Approximate Programme time (min)*	10	80	75	68	65

*NOTE: These times are approximate as they are dependent upon your household water pressure.

Use of the Programmes

- Prewash
 - Use each day when utensils are collected over a period of several days to prevent food deposits from becoming hardened.
- Super wash
 - Use when dealing with heavily soiled items such as pots and pans, oven fittings, teapot, or anything else with baked-on food deposits.
- Normal wash
 - Suitable for most loads including those collected over several days providing Prewash has been used.
- Economy wash
 - Suitable for light to normal soiled utensils which are to be washed on the same day.
- Quick wash
 - Use for those lightly soiled utensils which you urgently require.

When the washing-up is done

The machine stops automatically when the programme is finished.

Switching off (Model DC23)

The first thing you should do is to switch the machine off by pressing the On/Off button (the mains indicator light will go out). Switch off the power at the mains socket.

Switching off (Model DC24)

The Programme Selector knob will be in the ● Off position when the programme is finished. Turn the Temperature On/Off knob to the ● Off position. Switch off the power at the mains socket.

Turn off the water

If you have finished washing always turn off the water at the stopcock or tap.

If you do not have permanent plumbing you will also need to disconnect the water supply and stow the drain hose after emptying it in a bucket.

Unloading

Allow the load to cool for about 15 minutes.

Unload the lower rack before the upper rack to avoid any drops of water falling on the lower dishes when the upper rack is moved.

Caring for your Dishwasher

Your Hotpoint dishwasher needs very little attention. The following steps will keep it performing well.

NOTE: Before doing any cleaning check that the electricity supply to the machine is switched off.

1. Clean the spray arms occasionally. Remove the upper spray arm by turning the collar located above the arm in a clockwise direction. Remove the lower spray arm by pulling upwards. Brush them under fresh running water or use a mild soap or detergent solution. They need to be kept clean to keep the jets clear and spraying properly.
 2. Clean the metal surfaces on the outside of your machine with a damp cloth only. **Do not use** any abrasive cleaners or metal polishes, otherwise you will damage the protective coating on these parts.
 3. If the machine is not going to be used for a long time leave the door ajar to allow air to circulate inside.
 4. We recommend you take out a Hotpoint Service Cover Plan with annual safety/maintenance check which ensures the machine is professionally serviced every year. Details are given on page 29 of this Handbook.
- Hotpoint strongly recommends that all of its appliances are regularly checked for electrical and mechanical safety whether or not they are covered by a Hotpoint Service Cover Plan. This is to avoid such things as worn hoses which may cause a leak on an appliance which could become dangerous if neglected.

WARNING: IT IS POSSIBLE FOR CHILDREN TO CLIMB INTO DISHWASHERS AND INJURE THEMSELVES. ALWAYS SWITCH ELECTRICITY OFF AT SOCKET AND REMOVE PLUG AFTER USE.